

9.2 EXTERIOR(1)

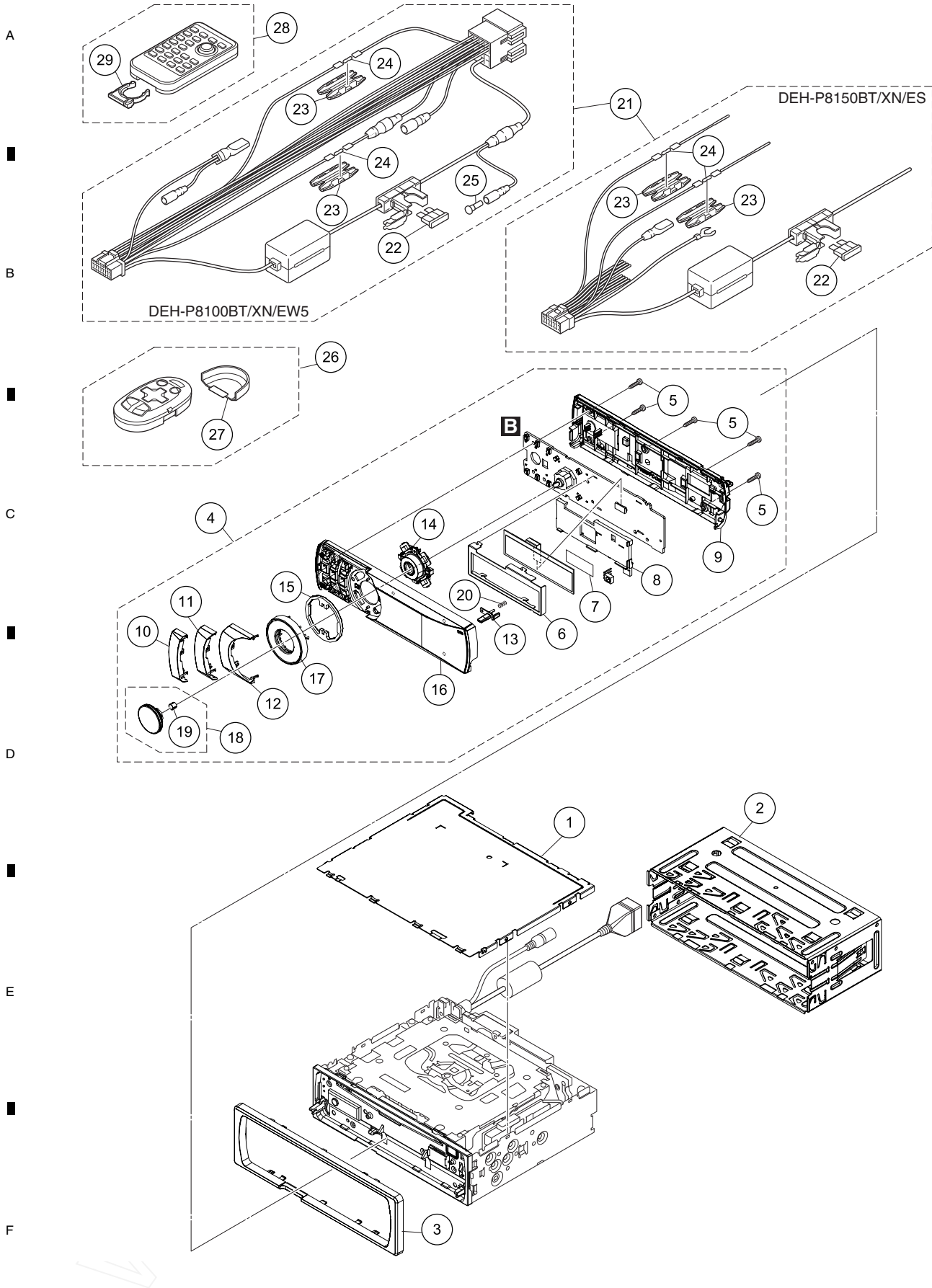

DEH-P8100BT/XN/EW5