

5.2 EXTERIOR SECTION

1

2

3

4

A

B

C

D

E

F

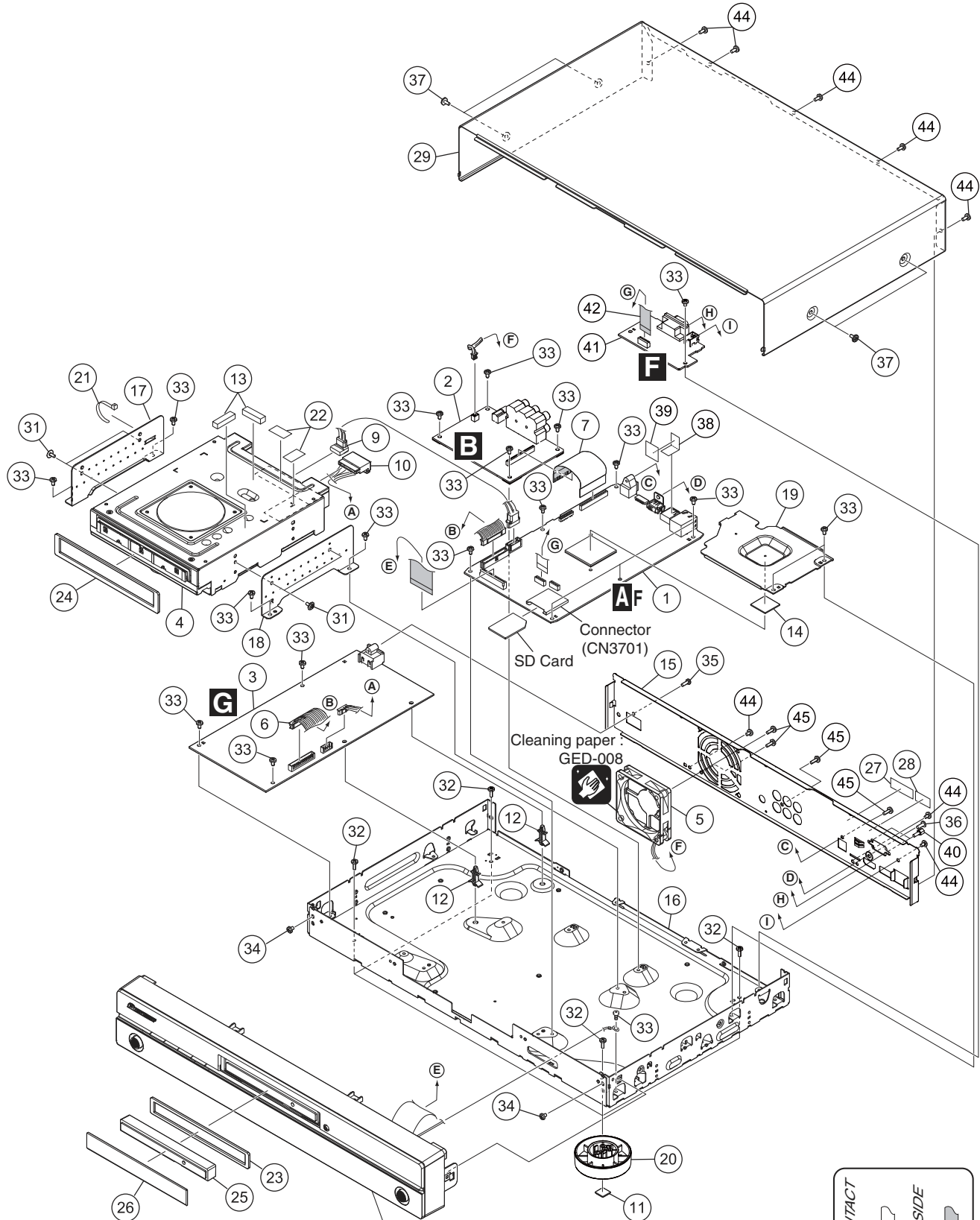

Refer to "5.3 FRONT PANEL SECTION."

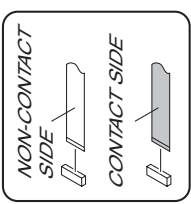

1

2

3

4